

LED CCT Soft Panel 200 (Yoke Mount)

■ LAMPHEAD CONTENTS

- Lamp Housing with DMX
- Stirrup with Ø28mm Spigot
- AC Cable
- DC Cable

* M.O. = Manual Operated
P.O. = Pole Operated

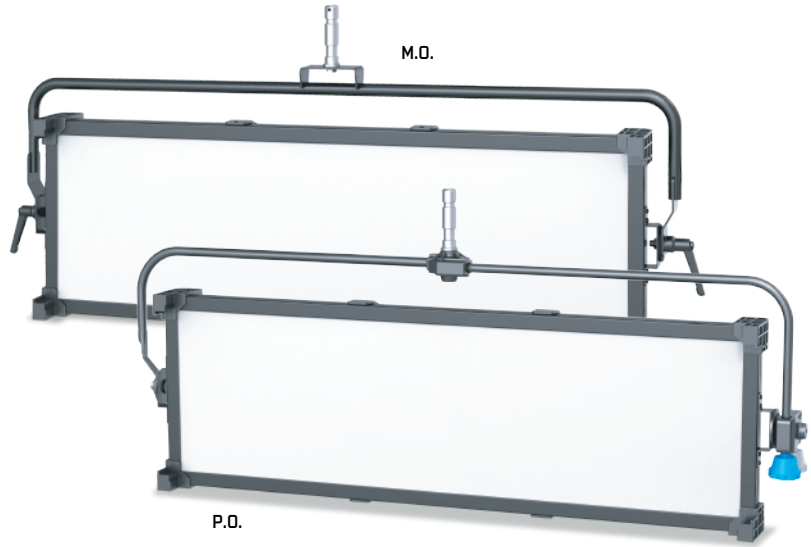

LED CCT Soft Panel 200(Yoke Mount)

■ SPECIFICATIONS

Identity No.	L002SLSB(M.O.)	
	LP02SLSB(P.O.)	
Max. Capacity	200W	
Voltage	95 - 265V AC	
	22 - 36V DC	
Frequency	50Hz / 60Hz	
Current	1A @ 220V 50Hz AC	
	2A @ 110V 60Hz AC	
	7A @ 30V DC	
Color Temp.	Adjustable 2700K - 5600K	
CRI	>95	
TLCI	>95	
Dimming Range	0-100%	
Control Signal	DMX 512	
DMX Channel	2	
LED Life	Approx. 30,000 Hrs	
M.O. / P.O. Stirrup	Ø28mm(1-1/8 in.) Spigot	
Class / IP Rating	1 / IP 23	
Max. Surface Temp.	70 °C	(158 °F)
Max. Ambient Temp.	45 °C	(113 °F)
Operating Range	+90° ~ 0° ~ -90°	
Weight	(M.O.): 15.0 kg	(33 lbs)
	(P.O.): 17.0 kg	(37 lbs)

■ ACCESSORIES

- 4-leaf Barndoor
- Eggcrate
- P.O. Stirrup with Ø28mm (1.1 in) Spigot
- Safety Cable(for lamphead)

■ DIMENSIONS (in)

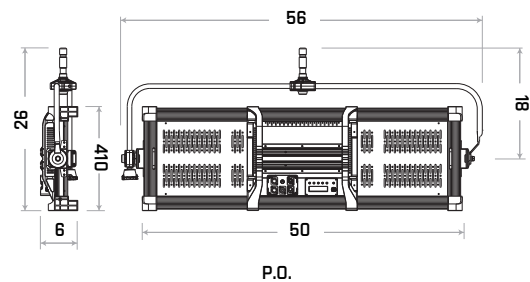
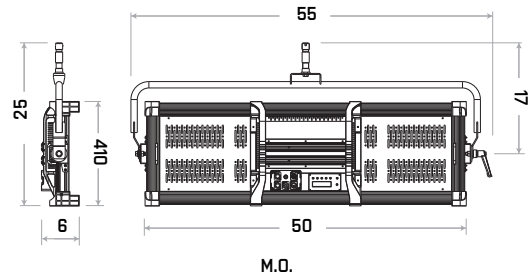

■ CONTROL PANEL

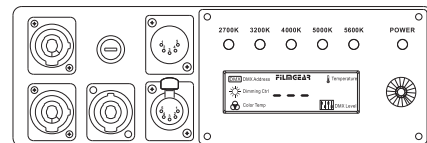

■ PHOTOMETRIC DATA

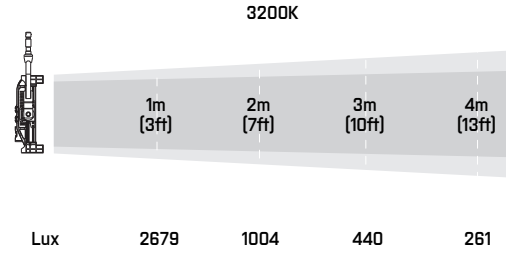
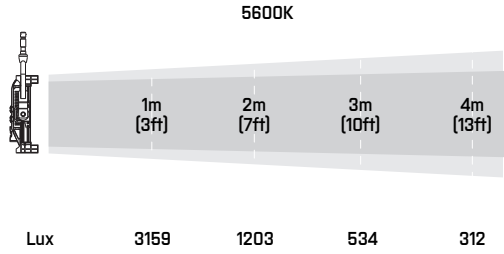

■ SPECTRUM

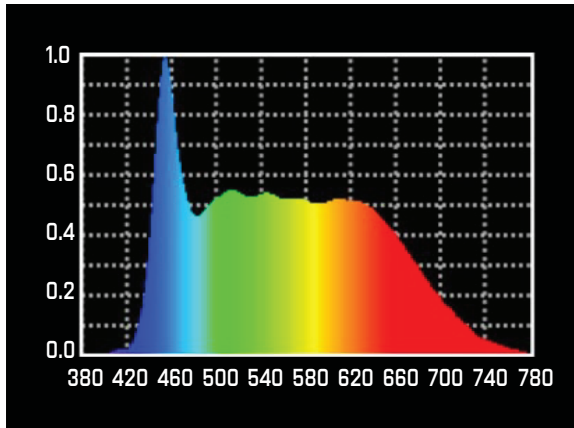

■ HISTOGRAM

